

# TASCAM

D01278620C

# iXR

## USB Audio/MIDI Interface

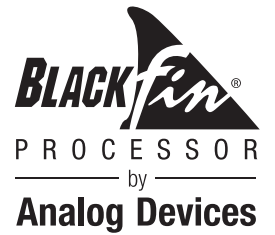

### REFERENCE MANUAL

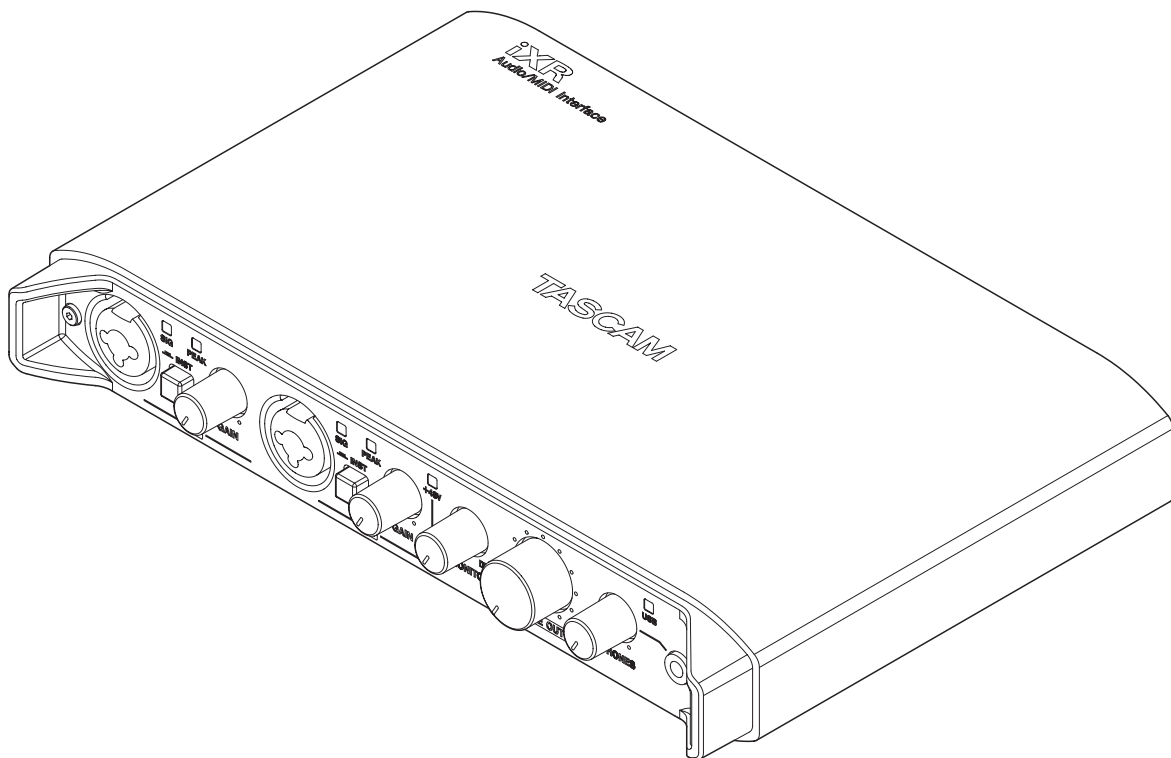

Before connecting this unit to a computer, you must install dedicated software on the computer.

# Contents

<b>1 – Introduction .....</b>	<b>3</b>	<b>8 – Application Guide .....</b>	<b>16</b>
Features .....	3	DAW software settings .....	16
Conventions used in this manual .....	3	Cubasis LE .....	16
Trademarks and copyrights.....	3	Cubase LE.....	16
<b>2 – Names and Functions of Parts .....</b>	<b>4</b>	Other DAW software.....	16
Front panel .....	4	Driver selection according to use (Windows only).....	16
Rear panel.....	5	Windows Media Player.....	16
<b>3 – Installation .....</b>	<b>6</b>	OS X and iTunes.....	17
System requirements.....	6	<b>9 – MIDI Implementation Chart .....</b>	<b>18</b>
iOS device system requirements.....	6	<b>10 – Troubleshooting .....</b>	<b>19</b>
Windows system requirements .....	6	<b>11 – Specifications .....</b>	<b>21</b>
Mac system requirements.....	6	Audio resolution.....	21
Supported audio/MIDI drivers .....	6	Input/output ratings.....	21
Installing the dedicated software.....	6	Analog audio input ratings.....	21
Installing the iOS Settings Panel.....	6	Analog audio output ratings.....	21
Installing the Windows driver.....	7	Control input/output ratings .....	21
Installing the Mac Settings Panel.....	8	Audio performance.....	21
Working with Gatekeeper.....	8	Operation requirements .....	22
Uninstalling the dedicated software .....	9	iOS devices .....	22
Uninstalling the iOS Settings Panel.....	9	Windows.....	22
Uninstalling the Windows driver .....	9	Mac.....	22
Uninstalling the Mac Settings Panel .....	9	Supported audio/MIDI drivers .....	22
<b>4 – Preparation.....</b>	<b>10</b>	General .....	22
Connecting the power .....	10	Dimensional drawings .....	23
When using an iOS device .....	10		
When using a computer (Windows/Mac).....	10		
<b>5 – Connections.....</b>	<b>11</b>		
Connecting other equipment .....	11		
Computer connection.....	12		
Audio connections .....	12		
Connecting microphones .....	12		
Connecting guitars.....	12		
Connecting electronic instruments and other audio equipment .....	12		
Connecting monitor speakers.....	12		
Connecting headphones .....	12		
MIDI connections.....	12		
<b>6 – Using the Settings Panel .....</b>	<b>13</b>		
Opening the Settings Panel .....	13		
iOS device .....	13		
Windows.....	13		
Mac.....	13		
Settings Panel overview .....	13		
<b>7 – Standalone Mode.....</b>	<b>15</b>		
Overview .....	15		
Settings in standalone mode .....	15		

## Features

- 24-bit/96kHz audio interface
- Direct connection to the Lightning connector of an iOS device possible using an MFi certified USB A connector (using the Lightning-USB cable included with the iOS device)
- When using an iOS device, the AC adapter included with the iOS device can be connected to the unit's USB B connector so that the iOS battery is not used by the unit (power is not supplied to the iOS device either).
- The unit can be powered by USB bus power with just a USB connection when using it with a computer.
- Two analog signal channels (L/R) can be input simultaneously and output to a computer/iOS device by USB at the same time
- XLR connectors support balanced mic input and standard TRS jacks support balanced line input  
Electric guitars and basses, for example, can also be connected by standard TS phone jack input when the **MIC/LINE INST** switch is set to **INST** (instrument input)
- Balanced stereo line output using 2 standard 6.3mm (1/4") TRS jacks
- Headphone output by 3.5mm (1/8") stereo mini jack
- MIDI IN and OUT connectors
- Direct monitoring function allows input monitoring with low latency
- Driver and Settings Panel application for Windows included  
Settings panel applications for Macs and iOS devices
- Bundled DAW software (download editions)
  - Cubasis LE (for iOS)
  - Cubase LE (for Windows/Mac)

### ■ Note about computer operation

If you are unsure about anything related to the basic operation of a computer when it is mentioned in an explanation in this manual, please refer to the computer operation manual.

To use this unit with a computer, dedicated software must be installed on the computer.

For details about software installation, see "Installing the dedicated software" on page 6.

## Conventions used in this manual

The following conventions are used in this manual.

- Buttons, connectors and other physical parts of this unit are written using a bold font like this: **PHONES** knob.
- Information shown on a computer display is written like this: "OK".
- Additional information is provided as necessary in tips, notes and cautions.

### TIP

*These are tips about how to use the unit.*

### NOTE

*These provide additional explanations and describe special cases.*

### CAUTION

*Failure to follow these instructions could result in injury, damage to equipment or lost recording data, for example.*

## Trademarks and copyrights

- TASCAM is a trademark of TEAC CORPORATION, registered in the U.S. and other countries.
- Microsoft, Windows, Windows Vista and Windows Media are either registered trademarks or trademarks of Microsoft Corporation in the United States and/or other countries.
- Apple, Mac, Mac OS, OS X, iPad, iPhone, iPod touch, Lightning and iTunes are trademarks of Apple Inc.
- IOS is a trademark or registered trademark of Cisco in the U.S. and other countries and is used under license.
- AirPlay, iPad, iPhone, iPod, iPod classic, iPod nano, iPod touch, and Retina are trademarks of Apple Inc., registered in the U.S. and other countries. iPad Air, iPad mini, and Lightning are trademarks of Apple Inc. Only in Japan, the trademark "iPhone" is used with a license from Aiphone K.K.
- App Store is a service mark of Apple Inc.
- Cubase, Cubasis and VST are registered trademarks of Steinberg Media Technologies GmbH.
- ASIO is a trademark of Steinberg Media Technologies GmbH.
- Blackfin® and the Blackfin logo are registered trademarks of Analog Devices, Inc.
- Other company names, product names and logos in this document are the trademarks or registered trademarks of their respective owners.



# 2 – Names and Functions of Parts

## Front panel

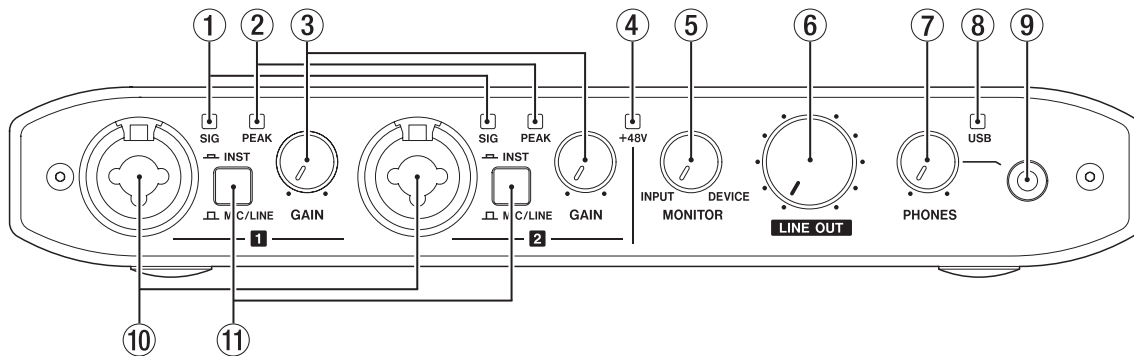

- ① **SIG indicators**  
The **SIG** indicators light green when a signal of at least  $-32$  dBFS is input through the **IN 1/IN 2** jacks.
- ② **PEAK indicators**  
The **PEAK** indicators light red when a signal that is  $-1$  dBFS (about to distort) or higher is input through the **IN 1/IN 2** jacks.
- ③ **GAIN knobs**  
Use to adjust the input levels of the **IN 1/IN 2** jacks.
- ④ **+48V indicator**  
The indicator lights when the phantom power switch on the back to the unit is set to **+48V**.
- ⑤ **MONITOR knob**  
Use to adjust the balance between the signals input through the unit's input jacks and the output of the device connected by USB.
- ⑥ **LINE OUT knob**  
Use to adjust the output level of the **LINE OUT 1/L-2/R** jacks.
- ⑦ **PHONES knob**  
Use to adjust the **PHONES** jack output level.
- ⑧ **USB indicator**  
This lights when the USB connection is active.  
This blinks when the USB connection is inactive.  
It is unlit when the unit is off.
- ⑨ **PHONES jack**  
Connect stereo headphones to this 3.5mm (1/8") stereo mini jack.  
The same signal is output from the **LINE OUT 1/L** and **2/R** jacks.  
Use an adapter to connect headphones with a standard 6.3mm (1/4") stereo plug.
- ⑩ **IN 1/IN 2 jacks**  
These are XLR/TRS combo input jacks.  
Use the **MIC/LINE INST** switches on the front of the unit to enable balanced line (**MIC/LINE**) or unbalanced (**INST**) input for the TRS jacks.
- ⑪ **MIC/LINE INST switches**  
Set according to the **IN 1/IN 2** jack input sources.  
Set to **MIC/LINE** when connecting electronic instruments, audio devices, mics and similar equipment. Set to **INST** when connecting an electric guitar, electric bass or other equipment with high output impedance.

### CAUTION

*Before connecting headphones, use the **PHONES** knob to minimize the volume. Failure to do so might cause sudden loud noises, which could harm your hearing or result in other trouble.*

## 2 – Names and Functions of Parts

### Rear panel

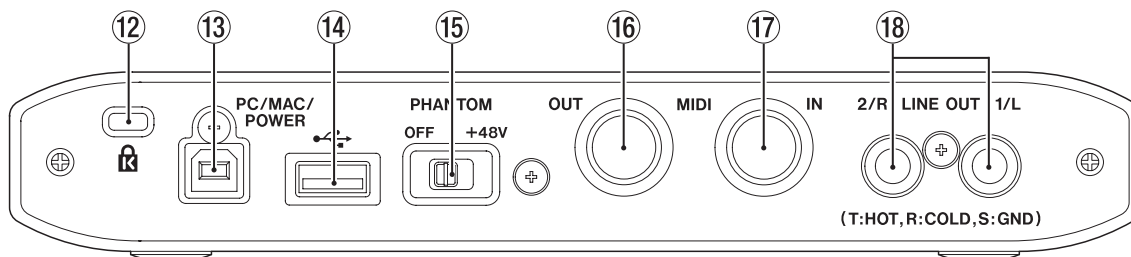

12 **Kensington Security Slot**

13 **PC/MAC/POWER port (USB B-type)**

When using this unit with an iOS device, use the included USB cable to connect the USB power adapter included with the iOS device. Doing this allows this port to function as a power supply connector.

When using this unit with a computer, use the included USB cable to connect it to the computer.

14 **USB port (USB A-type)**

To connect this unit with an iOS device, use the Lightning-USB cable included with the iOS device.

**NOTE**

*This port will not provide power to the iOS device, nor will it draw power from the device.*

15 **PHANTOM switch**

Use this switch to provide +48V phantom power to the **IN 1/IN 2** jacks.

16 **MIDI OUT connector**

This 5-pin DIN is a standard MIDI output jack. This outputs MIDI signals.

17 **MIDI IN connector**

This 5-pin DIN is a standard MIDI input jack. Use this to input MIDI signals.

18 **LINE OUT 1/L and 2/R jacks**

These standard TRS jacks are analog line outputs.

Use the Settings Panel to set the signals output from the **LINE OUT 1/L** and **2/R** jacks.

(Tip: HOT, Ring: COLD, Sleeve: GND)

# 3 – Installation

---

## System requirements

---

For the latest information about supported operating systems, visit the TEAC Global Site (<http://teac-global.com/>).

---

## iOS device system requirements

- **Supported operating systems**  
Apple device using iOS 9 or later

---

## Windows system requirements

- **Supported operating systems**  
Windows 10 32-bit  
Windows 10 64-bit  
Windows 8.1 32-bit  
Windows 8.1 64-bit  
Windows 7 32-bit SP1 or later  
Windows 7 64-bit SP1 or later  
(Windows Vista and Windows XP are not supported)
- **Computer hardware requirements**  
Windows computer with a USB 2.0 port
- **CPU/processor speed**  
2 GHz or faster dual core processor (x86)
- **Memory**  
2 GB or more

### CAUTION

*Operation of this unit was confirmed using standard computers that meet the above requirements. This does not guarantee operation with all computers that meet the above requirements. Even computers that meet the same system requirements might have processing capabilities that differ according to their settings and other operating conditions*

---

## Mac system requirements

- **Supported operating systems**  
macOS Sierra (10.12 or later)  
OS X El Capitan (10.11 or later)  
OS X Yosemite (10.10 or later)  
OS X Mavericks (10.9.1 or later)  
OS X Mountain Lion (10.8.4 or later)
- **Computer hardware requirements**  
Mac with a USB 2.0 port
- **CPU/processor speed**  
2 GHz or faster dual core processor
- **Memory**  
2 GB or more

---

## Supported audio/MIDI drivers

- **iOS devices**  
Core Audio for iOS
- **Windows**  
ASIO 2.0, WDM, MIDI
- **Mac**  
Core Audio, Core MIDI

---

## Installing the dedicated software

---

To use this unit with a computer, dedicated software must be installed on the computer.

With some exceptions, the latest software for the operating system you are using can be downloaded from the TEAC Global Site (<http://teac-global.com/>).

- To use this unit with an iOS device, install the TASCAM Settings Panel for Audio Interface app. The standard iOS driver will be used. The Settings Panel app can be downloaded from the App Store for free.
- To use this unit with a Windows computer, install the Windows driver. When you install the Windows driver, the Windows Settings Panel application will be installed at the same time.
- To use this unit with a Mac, install the Mac Settings Panel application. The standard OS driver will be used.

### CAUTION

*Before starting to install software, quit other applications.*

---

## Installing the iOS Settings Panel

Find the TASCAM Settings Panel for Audio Interface app on the App Store and download it.

Downloading it will install it automatically.

## Installing the Windows driver

### CAUTION

- Complete installation of the Windows driver on the computer before connecting the unit to it with the USB cable.
- If you already connected the unit to the computer using the USB cable before installing the Windows driver and the Found New Hardware Wizard launched, close the message and disconnect the USB cable.

### Windows driver installation procedures

1. Download the latest Windows driver for the operating system you are using from the TEAC Global Site (<http://teac-global.com/>) and save it on the computer to be used with the unit.
2. Open the saved Windows driver (zip file) on the computer desktop or another location.
3. Double-click the “iXR\_Installer\_XXX.exe” (XXX is the version number), file in the folder that appears after uncompression to automatically launch the installation software.

### CAUTION

If you open a zip file without decompressing it and double-click the “exe” file in the folder that opens, installation will not start. Right-click the zip file and select “Extract All”, for example, to uncompress it and then try again.

4. When a “Security Warning” or “User Account Control” screen appears, click the “Run” or “Yes” button.
5. When the Setup Wizard screen appears, click the “Next” button.

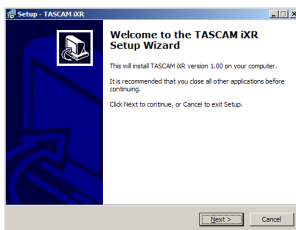

6. Read the contents of the License Agreement, and select “I accept the agreement” if you agree to the terms. Then, click the “Next” button.

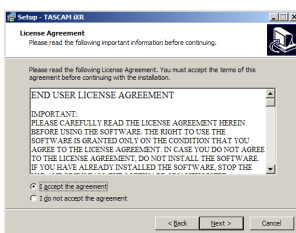

7. Next, click the “Install” button to start installation.

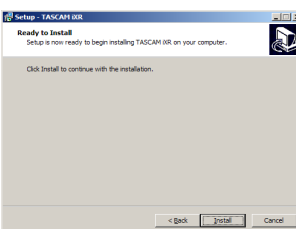

8. A Windows security screen will appear twice. Click the “Install” button to proceed with installation.

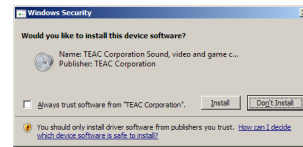

9. The following screen appears when installation has completed. Click the “Finish” button.

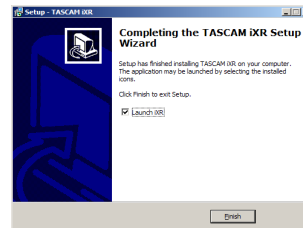

### NOTE

After installing the driver, the device driver will be installed the first time the unit is connected by USB.

At this time, Windows will automatically search Windows Update, and it may take some time to recognize the unit connection.

If the unit is still not recognized after some time, open the software installation screen from the message area at the bottom right of the computer display, and click “Skip Obtaining Drivers From Windows Update” to cancel the search.

# 3 – Installation

## Installing the Mac Settings Panel

### NOTE

- *Install the Settings Panel on the computer before connecting the unit to it with the USB cable.*
- *Depending on the Gatekeeper setting, a warning message might appear during installation. To resolve an issue with Gatekeeper, follow the instructions in “Working with Gatekeeper” on page 8 and then proceed with the installation.*

### ■ Mac Settings Panel installation procedures

1. Download the latest Mac Settings Panel for the operating system you are using from the TEAC Global Site (<http://teac-global.com/>) and save it on the computer to be used with the unit.
2. Double-click “iXR\_Installer\_XXX.dmg” (XXX is the version number), which is the saved disk image file for the Mac Settings Panel, and double-click “iXR\_Installer.pkg” inside the folder that opens.



### NOTE

*Depending on the computer's settings, the downloaded zip file might not have opened automatically. In this case, open the zip file first and then double-click the disk image file.*

3. When the installer starts, click the “Continue” button.

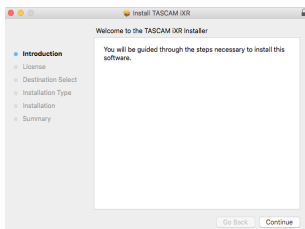

4. On the software license agreement screen, click the “Continue” button to open the software license agreement confirmation screen.

Click the “Read License” button and check the contents of the Software License Agreement. If you agree to the contents, click “Agree”.

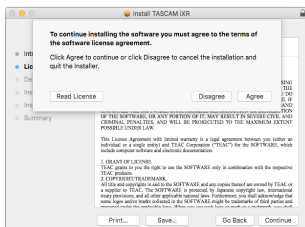

5. Next, click the “Install” button to start installation.

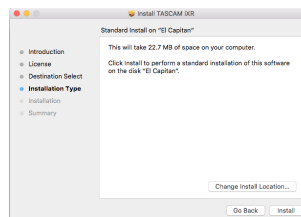

6. The following screen appears when installation has completed. Click the “Close” button.

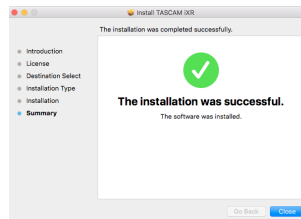

## Working with Gatekeeper

When using Mac OS X, depending on the Gatekeeper security function setting, a warning message might appear during installation.

The solution depends on the warning message shown. See the following explanations for details.

### ■ When the Gatekeeper setting is “Allow applications downloaded from: the Mac App Store”

The following security warning might be shown: “iXR\_Installer.dmg” can't be opened because it was not downloaded from the Mac App Store.”

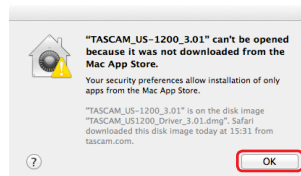

In this case, click the OK button to close the message. Then, control-click (or right-click) the file and click “Open”.

When the “iXR\_Installer.dmg” can't be opened because it was not downloaded from the Mac App Store. Are you sure you want to open it?” security warning message appears, click the “Open” button.

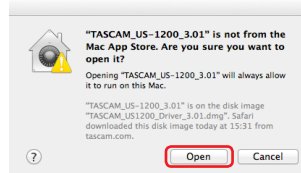

This warning message might also appear when the Gatekeeper setting is something other than “Allow applications downloaded from: the Mac App Store”.

The file still might not open and “iXR\_Installer.dmg” can't be opened because it was not downloaded from the Mac App Store.” might appear again.



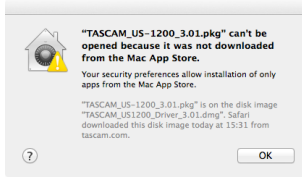

In this case, copy the file from the folder where it is to the desktop or another folder, and then open it. Alternatively, change the Gatekeeper settings to “Allow applications downloaded from: the Mac App Store and identified developers” and try opening it again.

### ■ When the Gatekeeper setting is not “Allow applications downloaded from: the Mac App Store”

“iXR\_Installer.dmg” is an application downloaded from the Internet. Are you sure you want to open it?” might appear as a security warning message. In this case, click the “Open” button.

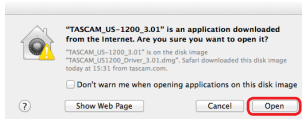

### ■ Changing the Gatekeeper setting

The Gatekeeper setting can be changed using the “Allow applications downloaded from:” item on the “General” page of the “Security & Privacy” pane of the System Preferences.

To change this, you must click the lock icon (🔒) at the bottom left and enter a password to unlock the settings.

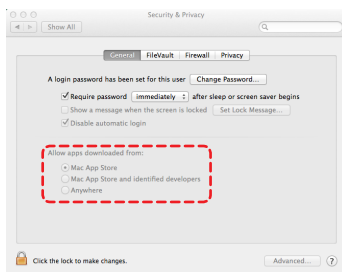

This setting will lock again when you click the “Show All” button to close the open pane or when you quit the System Preferences by, for example, clicking the (🔴) button or typing command-Q.

### CAUTION

*Changing the Gatekeeper setting could result in security risks.*

*If you changed the Gatekeeper setting to decrease security (use one of the lower settings), set it back to the original setting after updating the software and/or firmware. (When installing a firmware update immediately after software, do this after installing the firmware update.)*

## Uninstalling the dedicated software

### NOTE

*Normally, there is no need to uninstall the dedicated software. Follow these procedures if a problem occurs or you no longer intend to use the unit with the computer.*

### Uninstalling the iOS Settings Panel

Tap and hold the “TASCAM Settings Panel for Audio Interface” icon to show the × mark and enable app deletion. Tap the × mark to delete the app.

### Uninstalling the Windows driver

Uninstalling from the Programs and Features Control Panel.

1. From the Start menu, open the Control Panel and launch Programs and Features.

### NOTE

- *In Windows 10, right-click the Start button and click Control Panel when it appears.*
  - *In Windows 8.1, right-click the button at the bottom left of the Start screen and click Control Panel on the Apps screen.*
2. If “View by:” is set to “Category”, click “Uninstall a program” under the “Program” item. If “View by:” is set to “Large icons” or “Small icons”, click “Programs and Features”.
  3. Double-click “TASCAM iXR” in the list.
  4. Then, follow the instructions that appear on the screen.

### Uninstalling the Mac Settings Panel

Delete “iXR\_Settings Panel” from the Application folder to complete uninstallation.

# 4 – Preparation

---

## Connecting the power

---

### When using an iOS device

Connect the USB power adapter included with the iPad or iPhone to the USB cable included with this unit, and connect the cable to the **PC/MAC/POWER** port.

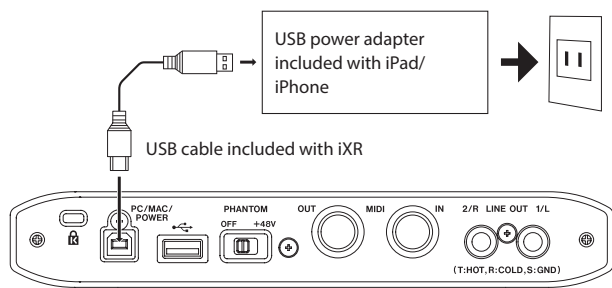

### CAUTION

- *No USB power adapter is included with the iPod touch. To use an iPod touch with this unit, purchase a genuine Apple USB power adapter (that supplies 5 V and at least 700 mA current).*
- *Operation with other USB power adapters is possible, but we strongly recommend using the genuine Apple USB power adapter included with the iPad/iPhone.*

*When using another USB power adapter, be sure that the power supply device meets the following specifications.*

- *Supplied voltage: 5 V*
- *Supplied current: 700 mA or more*

*Using a power supply device with specifications other than the above could cause malfunction, overheating, fire or other problems. If anything abnormal occurs, stop use and contact the store where you purchased this unit or a TASCAM customer support service to request repair.*

---

### When using a computer (Windows/Mac)

Normally, when this unit is connected to a computer, it will operate using USB bus power, so connecting a separate power supply device is not necessary.

# 5 – Connections

## Connecting other equipment

### ■ Precautions before making connections

- Carefully read the operation manuals of the devices to be connected and then connect them correctly.
- Before making connections, turn this unit and all equipment to be connected off (standby).
- If possible, install all connected devices so that they are powered from the same AC power supply line. When using a power strip or similar device, be sure to use one that has high current capacity in order to minimize voltage fluctuations in the AC power supply.

### ■ Front panel connections

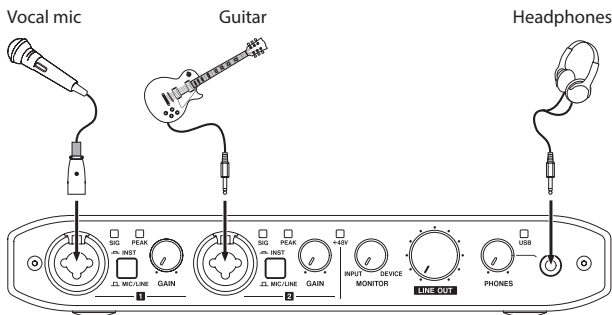

Examples of connections with other equipment (front)

### ■ iOS device connections

Use the Lightning-USB cable included with the iOS device to connect the iOS device's Lightning connector to the  port on the unit.

When the connection is working, the USB indicator on the front of the unit lights.

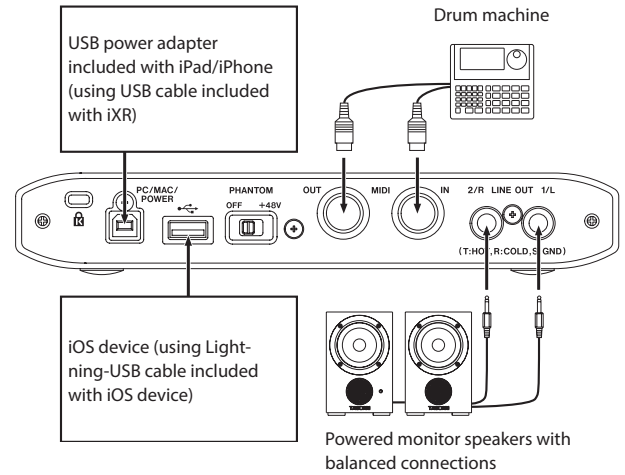

Use example with an iOS device (rear)

- Connect the USB power adapter included with the iPad or iPhone to the USB cable included with this unit, and connect the cable to the **PC/MAC/POWER** port.
- Use the Lightning-USB cable included with the iOS device to connect the iOS device to the  port on the unit.
- No USB power adapter is included with the iPod touch. To use an iPod touch with this unit, purchase a genuine Apple USB power adapter (that supplies 5 V and at least 700 mA current).

### ■ Windows/Mac connections

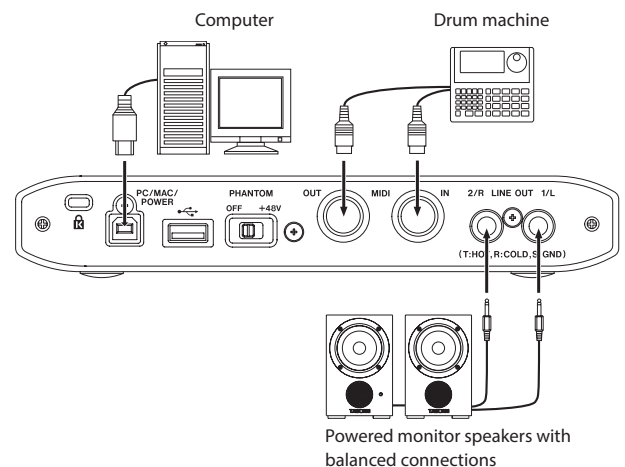

Use example with a computer (rear)

# 5 – Connections

## Computer connection

Use the included USB cable to connect the unit to a computer USB 2.0/3.0 port. When the USB connection is working, the USB indicator on the front of the unit lights.

### CAUTION

*If you connect this unit to a computer via a USB hub, for example, audio signal dropouts, clicking noises and other interference could occur due to the influence of other USB devices connected to that hub. For this reason, we strongly recommend connecting this unit to a separate USB port. Connecting USB keyboards and mice, however, to the same bus should not be a problem.*

## Audio connections

Analog audio signals input into this device from mics, guitars, keyboards and other audio equipment can be converted into digital signals and transmitted to the computer via USB. In addition, by connecting speakers (through an amplifier if not powered) or headphones to this unit, you can monitor audio signals that are input to this unit and output from the computer.

### CAUTION

*Before connecting audio equipment, set the **GAIN**, **LINE OUT** and **PHONES** knobs to their lowest values. Failure to do so could cause sudden loud noises from monitoring equipment, and this could damage the equipment or harm hearing.*

## Connecting microphones

### ■ Dynamic mics

Connect to the **IN 1** and **IN 2** XLR jacks on the front of the unit.

### ■ Condenser mics

When using a condenser microphone that requires phantom power, connect it to an **IN 1** or **IN 2** XLR jack and then set the **PHANTOM** switch on the back of the unit to **+48V**.

When the **PHANTOM** switch is set to **+48V**, the **+48V** indicator on the front of the unit lights.

### CAUTION

- *Before making connections, turn this unit and all equipment to be connected off (standby).*
- *The **PHANTOM** switch turns phantom power on/off for both **IN 1** and **IN 2** XLR jacks simultaneously. Do not set phantom power to +48V when connecting a mic that does not require phantom power.*
- *Do not connect or disconnect mics when the **PHANTOM** switch is set to +48V. Doing so could cause a loud noise and might damage this unit and connected equipment.*
- *Set the **LINE OUT** and **PHONES** knobs to their minimum values before changing a **PHANTOM** switch setting to +48V or OFF. Depending on the connected mics, sudden loud noises from monitoring equipment could occur, and this could damage the equipment or harm hearing.*
- *Set the **PHANTOM** power switch to +48V only when using a condenser microphone that requires phantom power. Setting the **PHANTOM** switch to +48V when a dynamic mic or other mic that does not require it is connected could damage this unit and connected equipment.*
- *When using condenser mics that require phantom power and dynamic mics together, be sure to use balanced*

*dynamic mics. Unbalanced dynamic mics cannot be used when phantom power is enabled.*

- *Supplying phantom power to some ribbon mics will break them. If you are unsure, do not supply phantom power to a ribbon mic.*

## Connecting guitars

When connecting a guitar or bass guitar directly to this unit, use the **IN 1/IN 2** standard TRS jack on the front of the unit and set the **MIC/LINE INST** switch for that jack to **INST**.

## Connecting electronic instruments and other audio equipment

When connecting an electronic instrument or other audio equipment directly to this unit, use the **IN 1/IN 2** standard TRS jacks on the front of the unit and set their **MIC/LINE INST** switches to **MIC/LINE**.

## Connecting monitor speakers

Connect powered monitor speakers with balanced connections to the **LINE OUT 1/L** and **2/R** jacks on the back of the unit.

Use the **LINE OUT** knob on the front of the unit to adjust the speaker volume.

## Connecting headphones

Connect headphones to the **PHONES** stereo mini jack on the front of the unit.

### CAUTION

*Before connecting headphones, use the **PHONES** knob to minimize the volume. Failure to do so might cause sudden loud noises, which could harm your hearing or result in other trouble.*

## MIDI connections

Connect sound modules, keyboards, synthesizers, drum machines and other MIDI devices to the unit in the following manner.

- If you want to monitor sound from a MIDI device, connect its outputs to this unit's line inputs or use an external mixer.
- You can also use the **MIDI IN** and **MIDI OUT** connectors on the back of the unit to send and receive MIDI timecode (MTC). By doing this, you can use an application that supports MTC to synchronize a multitrack recorder (MTR) and MIDI devices.

### CAUTION

*When using Windows Media Player, if the "Sound and Audio Devices Properties" Control Panel "MIDI music playback (default device)" is set to "Microsoft GS Wavetable SW Synth", you will not be able to hear MIDI performances through this unit's **LINE OUT 1/L**, **2/R** or **PHONES** jacks.*

# 6 – Using the Settings Panel

## Opening the Settings Panel

You can use the Settings Panel to make useful function settings, including the sampling frequency (Windows only) and the buffer size (Windows only), as well as to select output and input signals. You can also check the unit firmware and software versions.

You can open the Settings Panel in the following ways.

### iOS device

Tap the “Settings Panel” icon on the Home Screen.

### Windows

#### Windows 10

- Click the Start button at the bottom left of the screen, and select “All Programs” and open “iXR Settings Panel” under TASCAM.

#### Windows 8.1

- Click the Start button to open the start screen.
- Click the “iXR Settings Panel” beneath “TASCAM” on the Apps screen, which can be opened by clicking the  button.

#### Windows 7

- Click the Start button at the bottom left of the screen, and select “All Programs” and open “iXR Settings Panel” under “TASCAM”.

### Mac

- Using the Finder, open the Applications folder and double-click “iXR Settings Panel” to open the Settings Panel.

#### NOTE

*In the Audio Devices window of the Audio MIDI Setup application, right-click (control-click) “iXR” (or click the settings icon when the unit name is selected) and click “Configure device...” to open the Settings Panel.*

## Settings Panel overview

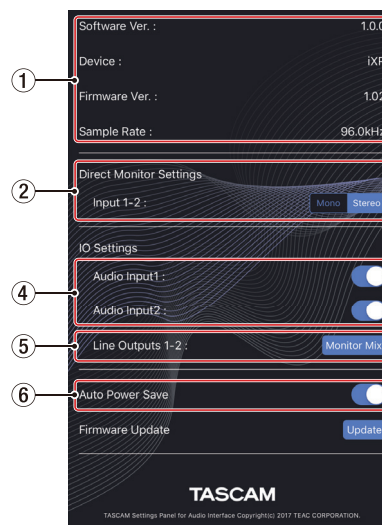

iOS Settings Panel

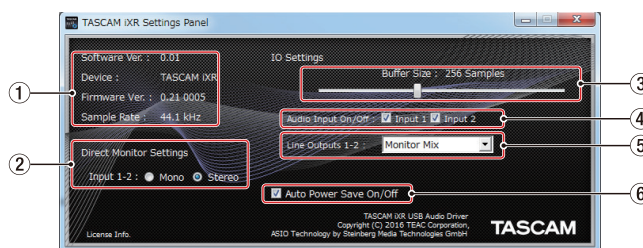

Windows Settings Panel

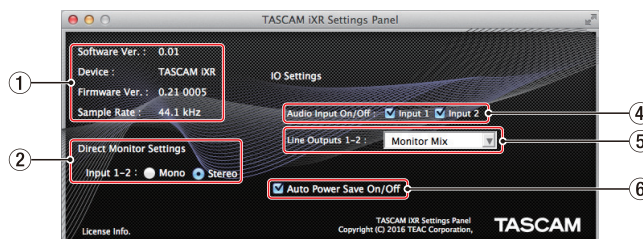

Mac Settings Panel

#### ① Status display area

This shows the current status of the software.

Item displayed	Meaning
Software Ver.	This is the software version.
Device	This is the name of the connected unit. (“No Device” is shown if no device is connected.)
Firmware Ver.	This is the firmware version used by the connected unit.
Sample Rate	This shows the sampling frequency.

## 6 – Using the Settings Panel

### ② Direct Monitor Settings

Set the signals input through the **IN 1/IN 2** jacks to Mono or Stereo for direct monitoring.

- When set to Mono  
Stereo signals sent to the iOS device/computer remain unchanged, but are output as mono signals from the **LINE OUT 1/L, 2/R** and **PHONES** jacks.
- When set to Stereo  
Stereo signals sent to the iOS device/computer remain unchanged, but are output as stereo signals from the **LINE OUT 1/L, 2/R** and **PHONES** jacks.

### ③ Buffer Size (Windows only)

The driver for the unit stores the audio input and output signals transferred to and from the computer temporarily in a buffer.

This buffer size can be adjusted.

Smaller buffer sizes result in less audio signal delay (latency), but require high-speed processing by the computer.

If the processing cannot keep up due to other system operations, for example, clicking and popping noises might occur and the audio signal might even drop out.

Increasing the buffer size will stabilize operation and suppress negative effects on audio signals, but the delay in audio signals sent to the computer will increase.

You can use the slider on the panel to adjust the buffer size, according to the use conditions.

Use the slider to select fixed values that increase from left to right.

Options

64, 128, 256, 512, 1024 or 2048 samples

### ④ Audio Input On/Off

Turn input on/off for each channel separately.

- When an input is set to on, signals input on that channel will be received.
- When an input is set to off, signals input on that channel will not be received.

### ⑤ Line Outputs 1-2

Select the signals to be output from the **LINE OUT 1/L, 2/R** and **PHONES** jacks.

Options

Monitor Mix

The signals from the input channels and the signals sent from the computer/iOS device by USB are mixed and output.

Use the **MONITOR** knob to adjust the mix balance.

xxxx Out 1-2 (Used with an iOS device)

Only the playback signals sent from the iOS device connected by USB are output. The connected iOS device name appears in place of "xxxx".

Computer Out 1-2 (Used with a computer)

Only the playback signals sent from the computer connected by USB are output.

### ⑥ Auto Power Save On/Off

When this setting is on, if operating in standalone mode and no input signal (above  $-60$  dBFS) has been detected for 30 minutes, the unit will turn itself off (enter standby) automatically.

Options

ON (default): The automatic power saving function is on.

OFF: The automatic power saving function is off.

### NOTE

*To turn the unit on again after the Auto Power Save function has turned it off automatically, disconnect and reconnect the cable connected to the PC/MAC/POWER port.*

---

## Overview

---

- This unit will operate in standalone mode when it is on and data is not being transmitted by USB to and from an iOS device/computer.
- You can use this unit as a mic preamp and to monitor input signals. This function is convenient when you want to practice an instrument without recording, for example.
- When operating in standalone mode, the **USB** indicator will blink.

---

## Settings in standalone mode

---

The Settings Panel will be set as follows when in standalone mode.

- Direct Monitor Settings Input 1-2: Last setting is retained
- Audio Input On/Off: All on
- Line Outputs 1/L-2/R: MONITOR
- ERP2 Setting On/Off: Last setting is retained

# 8 – Application Guide

In this chapter, we explain how to set some audio applications for use with this unit.

## DAW software settings

### Cubasis LE

Find Cubasis LE on the Apple App Store and download it. See the Cubasis LE manual for information about its settings.

#### NOTE

Follow these procedures to enable the Cubasis LE input signal.

- Tap the Settings icon on the iOS device home screen to open the Settings app.
- Scroll down the list of settings on the left side to Cubasis LE and tap it.
- When the settings screen opens to the right, turn the Mic setting on.

### Cubase LE

Download the Cubase LE Quick Start Guide from the product page on the TEAC Global Site (<http://teac-global.com/>), and refer to it for instructions about downloading, installing and making settings.

### Other DAW software

When using another DAW, consult its operation manual.

## Driver selection according to use (Windows only)

Set the ASIO driver in a DAW or other application to one of the following.

#### iXR

Select this when using a DAW or other application primarily for recording.

CUT Either ASIO applications or WDM applications can be used. Both types cannot be used at the same time. The performance might be improved depending on the use conditions.

#### iXR Mixing Driver

Select this when using a DAW or other application primarily for playback. Both ASIO and WDM applications can be used at the same time. The output of both ASIO and WDM applications can be mixed and output to the iXR.

## Windows Media Player

1. Open the OS Control Panel.

#### NOTE

Open the Control Panel in the following ways.

Windows 10/Windows 8.1

Right-click the Start button at the bottom left of the screen, and select "Control Panel".

Windows 7

Click the Start button at the bottom left of the screen, and select "Control Panel" from the Start menu.

2. Double-click Sound in the Control Panel.

#### NOTE

The Sound icon will be shown if the Control Panel "View by" is set to "icons".

3. On the Playback page, right-click "iXR" or "iXR Mixing Driver", and click "Set as Default Device" in the pop-up menu that appears.

When you do this, the green check mark (✓) appears next to "iXR" or "iXR Mixing Driver".

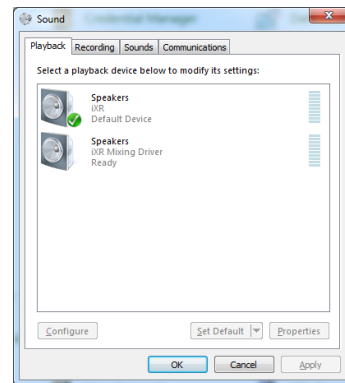

Screen in Windows 7

#### NOTE

To use this unit as the recording device, open the Recording page and use Set as Default Device for Line In iXR.

4. After completing the setting, click the OK button.
5. Launch Windows Media Player, select an audio file and start playback.

#### NOTE

- If you change the setting while Windows Media Player is running, the software will not recognize that the device has been changed. In this case, restart Windows Media Player.
- If you still cannot hear sound after making the settings and completing the procedures above, restart the computer.
- If you make this setting, sound will be output through this unit, but no sound will be output by the computer's speakers or headphone jack.



## OS X and iTunes

1. Open the Utilities folder in the Applications folder, and double-click “Audio MIDI Setup”. Then open the “Audio Devices” window.
2. Click “iXR” to select it and right-click or control-click it. Then, click “Use this device for sound output” in the pop-up menu.

The speaker mark appears next to “iXR”.

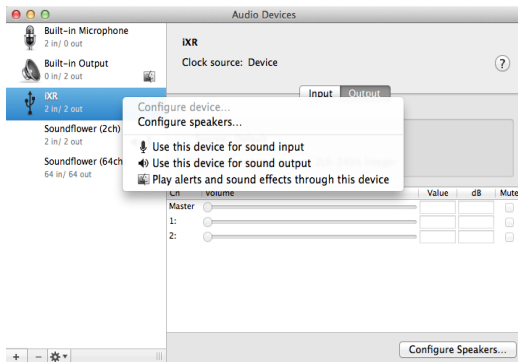

### NOTE

*To use this device as the recording device, select “Use this device for sound input” for the “iXR”.*

3. Launch iTunes, select an audio file and start playback.

# 9 – MIDI Implementation Chart

## ■ MIDI Implementation Chart

Function		Transmit	Recognize	Remarks
Basic channels	When power on	×	×	Thru
	Settable	×	×	
Mode	When power on	×	×	Thru
	Messages	×	×	
	Altered	.....		
Note number	Range	×	×	Thru
Velocity	Note on	×	×	Thru
	Note off	×	×	
Aftertouch	Polyphonic	×	×	Thru
	Channel	×	×	
Pitch bend		×	×	Thru
Control change		×	×	Thru
Program change		×	×	Thru
	Settable range	.....		
System exclusive		×	×	Thru
System common	Position	×	×	Thru
	Song select	×	×	
	Tune	×	×	
System real-time	Clock	×	×	Thru
	Command	×	×	
Other	Local on/off	×	×	Thru
	All notes off	×	×	
	Active sense	×	×	
	Reset	×	×	
Notes				

Mode 1: OMNI ON, POLY  
Mode 3: OMNI OFF, POLY

Mode 2: OMNI ON, MONO  
Mode 4: OMNI OFF, MONO

○: YES  
×: NO

# 10 – Troubleshooting

Please read this chapter if you are unable to use the unit properly even after setting it up following the procedures in this manual.

If you are still unable to resolve your problems please contact TASCAM customer support service with the following information about the operating environment and details about the trouble.

## ■ Operating environment

- Computer manufacturer
- Model
- CPU
- Memory (RAM)
- Operating system
- Applications used
- Antivirus software
- Wireless LAN use

See the end of this document for contact information.

## ■ The dedicated software cannot be installed

### 1. Check the operating system

The operating system you are using might not be supported by the software that you are trying to install.

Check the operating systems supported by the software that you are trying to install.

### 2. Stop software that is running in the background

Antivirus software and other software running in the background can interfere with installation.

Quit software running in the background and try installing again.

## ■ The unit will not turn on.

- When using an iOS device, a power supply device must be connected to the **PC/MAC/POWER** port. (See “iOS device connections” on page 11.)
- When using this unit with a computer, the computer must support USB bus power. Check the computer specifications.

## ■ The unit is connected, but the iOS device/computer does not recognize it.

### 1. Install the dedicated software

- If you have not done so, install the dedicated software. See “Installing the dedicated software” on page 6 for details.

### 2. Check the connection cable (when using an iOS device)

When connecting this unit to an iOS device, always use the Lightning-USB cable included with the iOS device.

Operation is not guaranteed with cables other than Apple genuine cables.

### 3. Change the USB port

- This unit will not work with USB 1.1. Use a USB 2.0 or USB 3.0 port.
- Do not use a USB hub. Always connect the unit directly to a USB port on the computer.
- If the above steps do not resolve the problem, connect the unit to a different USB port on the computer.

## ■ There is no sound even when audio is playing back on the computer.

Confirm that the unit's **MONITOR** knob is not turned all the way toward **INPUT**.

If that is the case, turn the **MONITOR** knob so that it is set to the **DEVICE** half of the range.

In addition, confirm the following while the unit is connected to the computer. Moreover, if you make the following settings, sound will be output through this unit, but no sound will be output by the computer's speakers or headphone jack.

## Windows

See the “Windows Media Player” section of “8 – Application Guide” on page 16, and set the default playback device as necessary for the OS.

## Mac

1. Quit all applications and open “System Preferences...” from the Apple menu.
2. Open “Sound”.
3. On the Output tab, select “iXR”.

After completing the setting, restart the computer and check the sound of playback. Depending on the application that you are using, you might need to make additional device settings.

In particular, DAW applications operate using audio engines with settings that are different from the OS settings, so confirm the DAW software driver settings first after installing the dedicated software for this unit.

Please see the manuals for the applications that you are using for detailed setting procedures.

## ■ Sound breaks up or there is noise.

The processing load on the computer causes sound to break up and noise to occur.

Here are some methods to reduce the load on the computer.

1. A wireless LAN and software running in the background, including antivirus software, put regular processing loads on the computer, which can cause sound to break up and other noise. Stop wireless LAN transmission, antivirus software and other software running in the background when using this unit.
2. Set the buffer size (latency) in the audio application that you are using or in this unit's Settings Panel to a larger value. (Windows only)

## NOTE

*Consult the maker of the audio application that you are using for methods to reduce its load on your computer.*

# 10 – Troubleshooting

3. Change the settings of your computer so that they are optimal for audio processing.

## Using Windows

- ① Open the Control Panel using the appropriate method of the OS you are using (Windows 10/Windows 8.1/Windows 7).
  - In Windows 10, from the Start button at the bottom left click “Control Panel” to open the Control Panel. Then, click the System icon.
  - In Windows 8.1, right-click the ordinary Start screen (Metro user interface screen) and then click “All apps”. Then, right-click “Computer” and select “Properties”.
  - In Windows 7, from the Start button at the bottom left right-click “Computer” and select “Properties”.
- ② Click “Advanced system settings”.
- ③ Click “Settings” in the “Performance” section of the “Advanced” tab of the “System Properties” window.
- ④ In the “Visual Effects” tab of the “Performance Options” window, select “Adjust for best performance”.

## Using Mac

- ① Open “System Preferences...” from the Apple menu, and select “Energy Saver”.
- ② Set “Computer sleep” to “Never”.
- ③ Set “Display sleep” to “Never”.

### NOTE

*Depending on the Mac OS version and Mac computer model, these settings might not be available.*

4. Change the USB port  
Since the unit might not properly function with some USB ports, try connecting it to a different USB port.

### NOTE

- *Try again after disconnecting other USB devices. (Keyboards and mice can be left connected.)*
- *Do not use a USB hub. Always connect the unit directly to a USB port on the computer (built-in)*

## ■ Support for Bundled DAW Software

TASCAM does not provide end-user support for the bundled DAW Software. Please check the Help menu of the installed software to find where this support is available.

---

## Audio resolution

---

### ■ Sampling frequencies

44.1, 48, 88.2, 96 kHz

### ■ Quantization bit depth

16/24-bit

---

## Input/output ratings

---

### Analog audio input ratings

#### ■ Mic inputs (balanced, IN 1/IN 2)

Connectors: XLR-3-31 equivalent (1: GND, 2: HOT, 3: COLD)

Input impedance: 2.2 k $\Omega$

Nominal input level (gain knob at MAX): -65 dBu (0.0004 Vrms)

Nominal input level (gain knob at MIN): -8 dBu (0.3090 Vrms)

Maximum input level: +8 dBu (1.9467 Vrms)

Gain range: 57 dB

#### ■ Instrument inputs (unbalanced, IN 1/IN 2)

(MIC/LINE INST switch set to INST)

Connectors: 6.3mm (1/4") standard TS jacks (Tip: HOT, Sleeve: GND)

Input impedance: 1 M $\Omega$  or more

Nominal input level (gain knob at MAX): -63 dBV (0.0007 Vrms)

Nominal input level (gain knob at MIN): -6 dBV (0.5015 Vrms)

Maximum input level: +10 dBV (3.162 Vrms)

Gain range: 57 dB

#### ■ Line inputs (balanced, IN 1/IN 2)

(MIC/LINE INST switch set to MIC/LINE)

Connectors: 6.3mm (1/4") standard TRS jacks (Tip: HOT, Ring: COLD, Sleeve: GND)

Input impedance: 10 k $\Omega$

Nominal input level (gain knob at MAX): -53 dBu (0.0017 Vrms)

Nominal input level (gain knob at MIN): +4 dBu (1.228 Vrms)

Maximum input level: +20 dBu (7.75 Vrms)

Gain range: 57 dB

---

### Analog audio output ratings

#### ■ Line outputs (balanced, LINE OUT 1/L-2/R)

Connectors: 6.3mm (1/4") standard TRS jacks (Tip: HOT, Ring: COLD, Sleeve: GND)

Output impedance: 110  $\Omega$

Nominal output level: +4 dBu (1.273 Vrms)

Maximum output level: +20 dBu (7.75 Vrms)

#### ■ Headphone output (PHONES)

Connector: 3.5mm (1/8") stereo mini jack

Maximum output: 18 mW + 18 mW or higher (THD+N 0.1% or less, into 32  $\Omega$  load)

---

### Control input/output ratings

#### ■ MIDI IN connector

Connector: 5-pin DIN

Format: standard MIDI

#### ■ MIDI OUT connector

Connector: 5-pin DIN

Format: standard MIDI

#### ■ Windows/Mac/Power port

Connector: 4-pin USB B-type

Transfer rate: USB 2.0 High Speed (480 Mbps)

#### ■ port

Connector: USB A-type

Transfer rate: USB 2.0 High Speed (480 Mbps)

---

### Audio performance

---

#### ■ Mic amp EIN (equivalent input noise)

-125 dBu or less (150 $\Omega$  termination, gain knob at MAX)

#### ■ Frequency response

IN 1/IN 2 jack to LINE OUT (BALANCED), headphone (PHONES) output

At 44.1/48 kHz

20 Hz: +0 dB/-0.4 dB (JEITA)

20 kHz: +0 dB/-0.1 dB (JEITA)

20 kHz: +0 dB/-0.5 dB (PHONES output, JEITA)

At 88.2/96 kHz

20 Hz: +0 dB/-0.4 dB (JEITA)

40 kHz: +0 dB/-0.25 dB (JEITA)

40 kHz: +0 dB/-2.0 dB (PHONES output, JEITA)

#### ■ S/N ratio

101 dB or higher

(MIC/LINE input to LINE OUT, gain knob at MIN, JEITA)

#### ■ Distortion

0.0025% or less (MIC/LINE input to LINE OUT, 1kHz sine wave, at nominal input level and maximum output level, JEITA)

#### ■ Crosstalk

95 dB or more (MIC/LINE input to LINE OUT, 1 kHz, JEITA)

# 11 – Specifications

---

## Operation requirements

---

Check the TEAC Global Site (<http://teac-global.com/>) for the latest information about supported operating systems.

---

### iOS devices

Apple iOS devices with a Lightning connector and running iOS 9 or later

---

### Windows

#### ■ Supported operating systems

Windows 10 32-bit  
Windows 10 64-bit  
Windows 8.1 32-bit  
Windows 8.1 64-bit  
Windows 7 32-bit SP1 or later  
Windows 7 64-bit SP1 or later  
(Windows Vista and Windows XP are not supported)

#### ■ Computer hardware requirements

Windows computer with a USB 2.0 port

#### ■ CPU/processor speed

2 GHz or faster dual core processor (x86)

#### ■ Memory

2 GB or more

#### CAUTION

*Operation of this unit was confirmed using standard computers that meet the above requirements. This does not guarantee operation with all computers that meet the above requirements. Even computers that meet the same system requirements might have processing capabilities that differ according to their settings and other operating conditions*

---

### Mac

#### ■ Supported operating systems

macOS Sierra (10.12 or later)  
OS X El Capitan (10.11 or later)  
OS X Yosemite (10.10 or later)  
OS X Mavericks (10.9.1 or later)  
OS X Mountain Lion (10.8.4 or later)

#### ■ Computer hardware requirements

Mac with a USB 2.0 port

#### ■ CPU/processor speed

2 GHz or faster dual core processor

#### ■ Memory

2 GB or more

---

## Supported audio/MIDI drivers

#### ■ iOS device

Core Audio for iOS

#### ■ Windows

ASIO 2.0, WDM, MIDI

#### ■ Mac

Core Audio, Core MIDI

---

## General

---

#### ■ Power

##### Used with a computer

USB bus power

##### Used with an iOS device

USB power adapter (that supplies 5 V and at least 700 mA current)\*1

Mobile battery (that supplies 5 V and at least 700 mA current)

TASCAM BP-6AA external battery pack

\*1 We strongly recommend using the USB power adapter included with the iPad/iPhone. No USB power adapter is included with the iPod touch. To use an iPod touch with this unit, purchase a genuine Apple USB power adapter (that supplies 5 V and at least 700 mA current).

#### ■ Power consumption

2.5 W

#### ■ External dimensions

210 × 35.3 × 140.7 mm (width × height × depth, including protrusions)

#### ■ Weight

660 g

#### ■ Operating temperature range

5–35 °C

#### ■ Bundled DAW software (download editions)

Steinberg Cubase LE

Steinberg Cubasis LE\*2

\*2 A demo version of Cubasis LE can be downloaded for free from the App Store. Connecting the iOS device to this unit will remove the restrictions of the demo version, allowing you to use it as a full version of Cubasis LE.

## Dimensional drawings

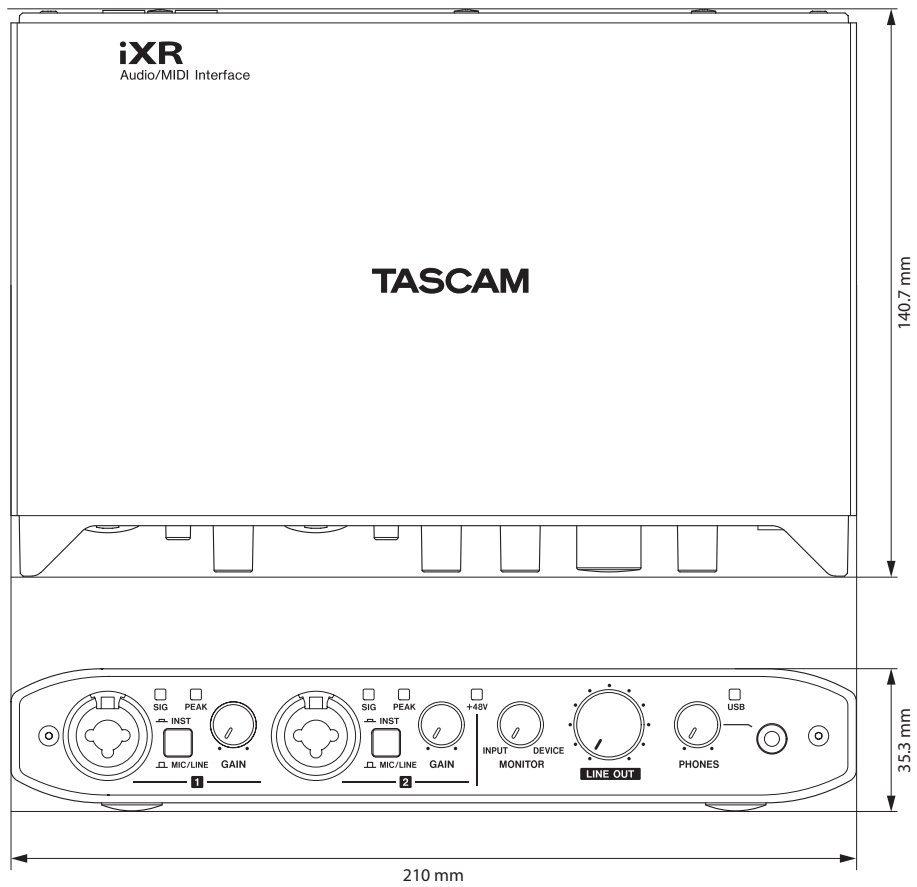

- Illustrations in this reference manual might differ in part from the actual product.
- Specifications and external appearance might be changed without notification to improve the product.

# TASCAM

## TEAC CORPORATION

Phone: +81-42-356-9143

1-47 Ochiai, Tama-shi, Tokyo 206-8530 Japan

<https://tascam.jp/jp/>

---

## TEAC AMERICA, INC.

Phone: +1-323-726-0303

1834 Gage Road, Montebello, California 90640 USA

<http://tascam.com/>

---

## TEAC UK Ltd.

Phone: +44-8451-302511

2 Huxley Road, Surrey Research Park, Guildford, GU2 7RE, United Kingdom

<http://tascam.eu/>

---

## TEAC EUROPE GmbH

Phone: +49-611-71580

Bahnstrasse 12, 65205 Wiesbaden-Erbenheim, Germany

<http://tascam.eu/>

---

## TEAC SALES & TRADING(SHENZHEN) CO., LTD

Phone: +86-755-88311561~2

Room 817, Block A, Hailrun Complex, 6021 Shennan Blvd., Futian District, Shenzhen 518040, China

<http://tascam.cn/>

---